



GreenSpace G6

DN391B LED12/830 PSD D150 AL WP GCG2HE

GreenSpace G6, 10.6 W, 1150 lm, 3000 K, DALI, Facetted reflector, Matte, IP54/20 | Dust accumulation protected, splash-proof/finger protected

Philips GreenSpace G6 builds on the GreenSpace family's reputation for superb performance, extremely low energy use, and high visual comfort. This next generation of reliable LED downlights comes in a highly-compact design with a deep, recessed architecture and increased reflector depth to highlight the smallest of details. GreenSpace G6 is also a shining example of versatility. This energy-saving LED downlight is available in a comprehensive range of configurations from 600 to 3,550 lumen, with the option to choose fixed, dimmable, or Interact Ready variants. This makes GreenSpace G6 the perfect 'mix and match' solution for potentially broad and extended applications that require different lighting ambiances, with one cohesive luminaire look and feel.

Product data

General Information		Operating and Electrical	
Number of gear units	-	Beam angle of light source	10 or 40 degree(s)
Gear	-	Light source color	830 warm white
Driver included	No	Optic type	Facetted reflector
Light source engine type	LED	Optical cover type	Polycarbonate Diffuser
		Unified glare rating CEN	Not applicable
Light Technical			
Luminous Flux	1,150 lm	Input Voltage	220 to 240 V
Luminous Efficacy (rated) (Nom)	111 lm/W	Line Frequency	50 or 60 Hz
Correlated Color Temperature (Nom)	3000 K	Inrush current	16.5 A
Color rendering index (CRI)	≥80	Inrush time	177 ms
Number of light sources	24	Power Consumption	10.6 W

GreenSpace G6

Power Factor (Fraction)	0.9
Connection	2 Push-in connector 2-pole
Cable	-
Number of products on MCB of 16 A type B 36	

Temperature

Ambient temperature range	-20 to +40 °C
---------------------------	---------------

Controls and Dimming

Dimmable	DALI
Control interface	DALI

Mechanical and Housing

Housing Material	Aluminum die-cast
Reflector material	Polycarbonate
Optic material	Polycarbonate
Optical cover material	Polycarbonate
Housing Color	Aluminum and RAL (to be defined)
Mounting device	Frame for recessed mounting
Optical cover finish	Matte
Overall height	80 mm
Overall diameter	162 mm

Approval and Application

Ingress protection code	IP54/20 [Dust accumulation protected, splash-proof/finger protected]
Mech. impact protection code	IK03 [0.3 J]
Protection class IEC	Safety class II
Glow-wire test	Temperature 650 °C, duration 5 s

Flammability mark	-
CE mark	CE mark
ENEC mark	-
Warranty period	3 years
EU RoHS compliant	Yes

Initial Performance (IEC Compliant)

Luminous flux tolerance	-10% / +10%
Initial chromaticity	5
Power consumption tolerance	+/-10%

Application Conditions

Performance ambient temperature Tq	25 °C
Maximum dim level	1%
Suitable for random switching	No

Product Data

Order product name	DN391B LED12/830 PSD D150 AL WP GCG2HE
Full product name	DN391B LED12/830 PSD D150 AL WP GCG2HE
Order code	911401570044
Material Nr. (12NC)	911401570044
Numerator - Quantity Per Pack	1
Net Weight (Piece)	0.490 kg
Numerator - Packs per outer box	1

Dimensional drawing

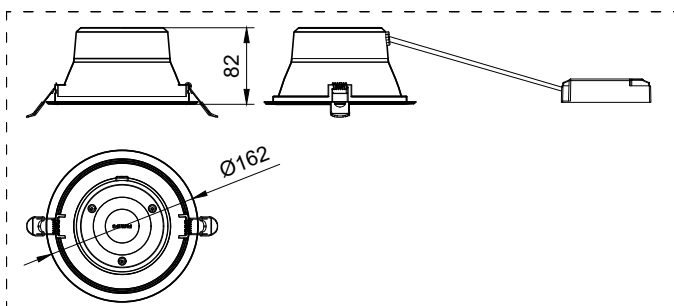

GreenSpace G6

