



# GreenSpace G6

## DN391B LED12/865 PSU D150 AL GCG2HE

GreenSpace G6, 9.8 W, 1250 lm, 6500 K, Facetted reflector, Matte, IP20 | Finger-protected

Philips GreenSpace G6 builds on the GreenSpace family's reputation for superb performance, extremely low energy use, and high visual comfort. This next generation of reliable LED downlights comes in a highly-compact design with a deep, recessed architecture and increased reflector depth to highlight the smallest of details. GreenSpace G6 is also a shining example of versatility. This energy-saving LED downlight is available in a comprehensive range of configurations from 600 to 3,550 lumen, with the option to choose fixed, dimmable, or Interact Ready variants. This makes GreenSpace G6 the perfect 'mix and match' solution for potentially broad and extended applications that require different lighting ambiances, with one cohesive luminaire look and feel.

### Product data

General Information		Optic type	
Number of gear units	-	Optical cover type	Facetted reflector
Gear	-	Unified glare rating CEN	Polycarbonate Diffuser
Driver included	Yes		16
Light source engine type	LED	Operating and Electrical	
Light Technical		Input Voltage	220 to 240 V
Luminous Flux	1,250 lm	Line Frequency	50 or 60 Hz
Luminous Efficacy (rated) (Nom)	132 lm/W	Inrush current	14 A
Correlated Color Temperature (Nom)	6500 K	Inrush time	0.01 ms
Color rendering index (CRI)	>80	Power Consumption	9.8 W
Number of light sources	1	Power Factor (Fraction)	0.9
Light source color	865 cool daylight	Connection	Flying leads/wires
		Cable	2×0.75mm <sup>2</sup> Cable 0.2 m without plug

# GreenSpace G6

Number of products on MCB of 16 A type B 204	
<b>Temperature</b>	
Ambient temperature range	-20 to +40 °C
<b>Controls and Dimming</b>	
Dimmable	No
Control interface	-
<b>Mechanical and Housing</b>	
Housing Material	Aluminum die-cast
Reflector material	Polycarbonate
Optic material	Polycarbonate
Optical cover material	Polycarbonate
Housing Color	Aluminum
Mounting device	Frame for recessed mounting
Optical cover finish	Matte
Overall height	80 mm
Overall diameter	162 mm
<b>Approval and Application</b>	
Ingress protection code	IP20 [Finger-protected]
Mech. impact protection code	IK03 [0.3 J]
Protection class IEC	Safety class II
Glow-wire test	Temperature 650 °C, duration 5 s
Flammability mark	-
CE mark	CE mark

ENEC mark	-
Warranty period	3 years
Photobiological risk	Photobiological risk group 1 @200mm to EN62778
EU RoHS compliant	Yes

## Initial Performance (IEC Compliant)

Luminous flux tolerance	+/-10%
Initial chromaticity	5
Power consumption tolerance	+/-10%

## Application Conditions

Performance ambient temperature Tq	25 °C
Maximum dim level	Not applicable
Suitable for random switching	No

## Product Data

Order product name	DN391B LED12/865 PSU D150 AL GCG2HE
Full product name	DN391B LED12/865 PSU D150 AL GCG2HE
Order code	911401532744
Material Nr. (12NC)	911401532744
Numerator - Quantity Per Pack	1
Net Weight (Piece)	0.340 kg
Numerator - Packs per outer box	4

## Dimensional drawing

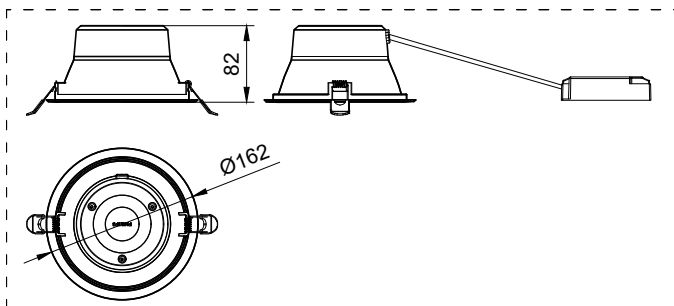

## GreenSpace G6

