



GreenSpace G6

DN392B LED20/865 PSU D150 WH GCG2HE

GreenSpace G6, 14.4 W, 2000 lm, 6500 K, White reflector and opal cover, Matte, IP20 | Finger-protected

Philips GreenSpace G6 builds on the GreenSpace family's reputation for superb performance, extremely low energy use, and high visual comfort. This next generation of reliable LED downlights comes in a highly-compact design with a deep, recessed architecture and increased reflector depth to highlight the smallest of details. GreenSpace G6 is also a shining example of versatility. This energy-saving LED downlight is available in a comprehensive range of configurations from 600 to 3,550 lumen, with the option to choose fixed, dimmable, or Interact Ready variants. This makes GreenSpace G6 the perfect 'mix and match' solution for potentially broad and extended applications that require different lighting ambiances, with one cohesive luminaire look and feel.

Product data

General Information		Optic type	
Number of gear units	-	White reflector and opal cover	
Gear	-	Optical cover type	
Driver included	Yes	Polycarbonate Diffuser	
Light source engine type	LED	Unified glare rating CEN	
		26	
Light Technical		Operating and Electrical	
Luminous Flux	2,000 lm	Input Voltage	220 to 240 V
Luminous Efficacy (rated) (Nom)	138 lm/W	Line Frequency	50 or 60 Hz
Correlated Color Temperature (Nom)	6500 K	Inrush current	10 A
Color rendering index (CRI)	>80	Inrush time	0.02 ms
Number of light sources	1	Power Consumption	14.4 W
Light source color	865 cool daylight	Power Factor (Fraction)	0.9
		Connection	Flying leads/wires
		Cable	2×0.75mm ² Cable 0.2 m without plug

GreenSpace G6

Number of products on MCB of 16 A type B 170	
Temperature	
Ambient temperature range	-20 to +40 °C
Controls and Dimming	
Dimmable	No
Control interface	-
Mechanical and Housing	
Housing Material	Aluminum die-cast
Reflector material	Polycarbonate
Optic material	Polycarbonate
Optical cover material	Polycarbonate
Housing Color	Aluminum
Mounting device	Frame for recessed mounting
Optical cover finish	Matte
Overall height	80 mm
Overall diameter	162 mm
Approval and Application	
Ingress protection code	IP20 [Finger-protected]
Mech. impact protection code	IK03 [0.3 J]
Protection class IEC	Safety class II
Glow-wire test	Temperature 650 °C, duration 5 s
Flammability mark	-
CE mark	CE mark

ENEC mark	-
Warranty period	3 years
Photobiological risk	Photobiological risk group 1 @200mm to EN62778
EU RoHS compliant	Yes

Initial Performance (IEC Compliant)

Luminous flux tolerance	+/-10%
Initial chromaticity	5
Power consumption tolerance	+/-10%

Application Conditions

Performance ambient temperature Tq	25 °C
Maximum dim level	Not applicable
Suitable for random switching	No

Product Data

Order product name	DN392B LED20/865 PSU D150 WH GCG2HE
Full product name	DN392B LED20/865 PSU D150 WH GCG2HE
Order code	911401531844
Material Nr. (12NC)	911401531844
Numerator - Quantity Per Pack	1
Net Weight (Piece)	0.340 kg
Numerator - Packs per outer box	4

Dimensional drawing

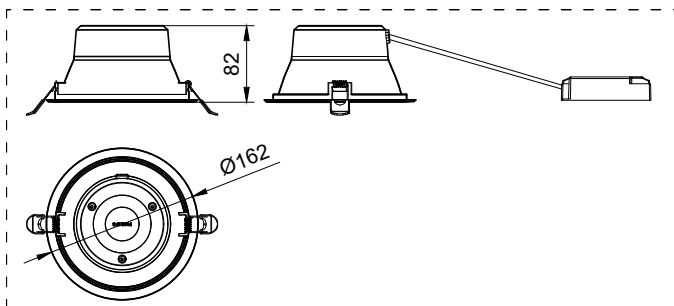

GreenSpace G6

