



# GreenSpace G6

## DN392B LED23/865 P17PSD D150 WH GMG2HE

GreenSpace G6, 17.3 W, 2300 lm, 6500 K, DALI, White reflector and opal cover, Matte, IP20 | Finger-protected

Philips GreenSpace G6 builds on the GreenSpace family's reputation for superb performance, extremely low energy use, and high visual comfort. This next generation of reliable LED downlights comes in a highly-compact design with a deep, recessed architecture and increased reflector depth to highlight the smallest of details. GreenSpace G6 is also a shining example of versatility. This energy-saving LED downlight is available in a comprehensive range of configurations from 600 to 3,550 lumen, with the option to choose fixed, dimmable, or Interact Ready variants. This makes GreenSpace G6 the perfect 'mix and match' solution for potentially broad and extended applications that require different lighting ambiances, with one cohesive luminaire look and feel.

### Product data

General Information		Operating and Electrical	
Number of gear units	-	Light source color	865 cool daylight
Gear	-	Optic type	White reflector and opal cover
Driver included	No	Optical cover type	Polycarbonate Diffuser
Light source engine type	LED	Unified glare rating CEN	Not applicable
Light Technical		Input Voltage	220 to 240 V
Luminous Flux	2,300 lm	Line Frequency	50 or 60 Hz
Luminous Efficacy (rated) (Nom)	135 lm/W	Inrush current	16.5 A
Correlated Color Temperature (Nom)	6500 K	Inrush time	177 ms
Color rendering index (CRI)	≥80	Power Consumption	17.3 W
Number of light sources	48	Power Factor (Fraction)	0.9
Beam angle of light source	10 or 40 degree(s)	Connection	2 Push-in connector 2-pole

# GreenSpace G6

Cable	-
Number of products on MCB of 16 A type B	36

## Temperature

Ambient temperature range	-20 to +40 °C
---------------------------	---------------

## Controls and Dimming

Dimmable	DALI
Control interface	DALI

## Mechanical and Housing

Housing Material	Aluminum die-cast
Reflector material	Polycarbonate
Optic material	Polycarbonate
Optical cover material	Polycarbonate
Housing Color	Aluminum and RAL (to be defined)
Mounting device	Frame for recessed mounting
Optical cover finish	Matte
Overall height	80 mm
Overall diameter	162 mm

## Approval and Application

Ingress protection code	IP20 [Finger-protected]
Mech. impact protection code	IK03 [0.3 J]
Protection class IEC	Safety class II
Glow-wire test	Temperature 650 °C, duration 5 s
Flammability mark	-

CE mark	CE mark
ENEC mark	-
Warranty period	3 years
EU RoHS compliant	Yes

## Initial Performance (IEC Compliant)

Luminous flux tolerance	-10% / +10%
Initial chromaticity	5
Power consumption tolerance	+/-10%

## Application Conditions

Performance ambient temperature Tq	25 °C
Maximum dim level	1%
Suitable for random switching	No

## Product Data

Order product name	DN392B LED23/865 P17PSD D150 WH GMG2HE
Full product name	DN392B LED23/865 P17PSD D150 WH GMG2HE
Order code	911401574044
Material Nr. (12NC)	911401574044
Numerator - Quantity Per Pack	1
Net Weight (Piece)	0.490 kg
Numerator - Packs per outer box	1

## Dimensional drawing

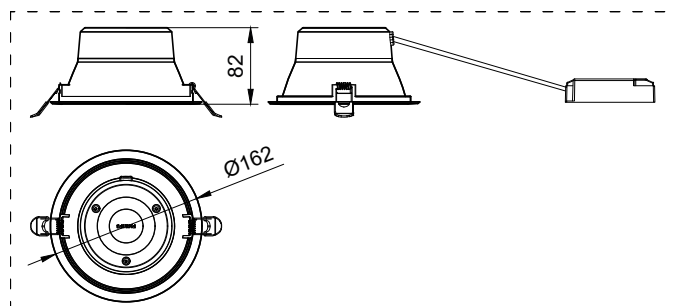

## GreenSpace G6

