



# GreenSpace G6

## DN393B LED25/840 P20PSD D200 ALWP GMG2HE

GreenSpace G6, 19.9 W, 2500 lm, 4000 K, DALI, Facetted reflector, Matte, IP54/20 | Dust accumulation protected, splash-proof/finger protected

Philips GreenSpace G6 builds on the GreenSpace family's reputation for superb performance, extremely low energy use, and high visual comfort. This next generation of reliable LED downlights comes in a highly-compact design with a deep, recessed architecture and increased reflector depth to highlight the smallest of details. GreenSpace G6 is also a shining example of versatility. This energy-saving LED downlight is available in a comprehensive range of configurations from 600 to 3,550 lumen, with the option to choose fixed, dimmable, or Interact Ready variants. This makes GreenSpace G6 the perfect 'mix and match' solution for potentially broad and extended applications that require different lighting ambiances, with one cohesive luminaire look and feel.

### Product data

General Information		Number of light sources	
Number of gear units	-	Number of light sources	48
Gear	-	Beam angle of light source	10 or 40 degree(s)
Driver included	No	Light source color	840 neutral white
Light source engine type	LED	Optic type	Facetted reflector
Light Technical		Optical cover type	Polycarbonate Diffuser
Luminous Flux	2,500 lm	Unified glare rating CEN	Not applicable
Luminous Efficacy (rated) (Nom)	130 lm/W	Operating and Electrical	
Correlated Color Temperature (Nom)	4000 K	Input Voltage	220 to 240 V
Color rendering index (CRI)	≥80	Line Frequency	50 or 60 Hz
		Inrush current	16.5 A

## GreenSpace G6

Inrush time	177 ms
Power Consumption	19.9 W
Power Factor (Fraction)	0.9
Connection	2 Push-in connector 2-pole
Cable	-
Number of products on MCB of 16 A type B	36

### Temperature

Ambient temperature range	-20 to +40 °C
---------------------------	---------------

### Controls and Dimming

Dimmable	DALI
Control interface	DALI

### Mechanical and Housing

Housing Material	Aluminum die-cast
Reflector material	Polycarbonate
Optic material	Polycarbonate
Optical cover material	Polycarbonate
Housing Color	Aluminum and RAL (to be defined)
Mounting device	Frame for recessed mounting
Optical cover finish	Matte
Overall height	107 mm
Overall diameter	216 mm

### Approval and Application

Ingress protection code	IP54/20 [Dust accumulation protected, splash-proof/finger protected]
Mech. impact protection code	IK03 [0.3 J]
Protection class IEC	Safety class II
Glow-wire test	Temperature 650 °C, duration 5 s

Flammability mark	-
CE mark	CE mark
ENEC mark	-
Warranty period	3 years
Photobiological risk	Photobiological risk group 1 @200mm to EN62778
EU RoHS compliant	Yes

### Initial Performance (IEC Compliant)

Luminous flux tolerance	-10% / +10%
Initial chromaticity	5
Power consumption tolerance	+/-10%

### Application Conditions

Performance ambient temperature Tq	25 °C
Maximum dim level	1%
Suitable for random switching	No

### Product Data

Order product name	DN393B LED25/840 P20PSD D200 ALWP GMG2HE
Full product name	DN393B LED25/840 P20PSD D200 ALWP GMG2HE
Order code	911401567544
Material Nr. (12NC)	911401567544
Numerator - Quantity Per Pack	1
Net Weight (Piece)	0.590 kg
Numerator - Packs per outer box	1

## Dimensional drawing

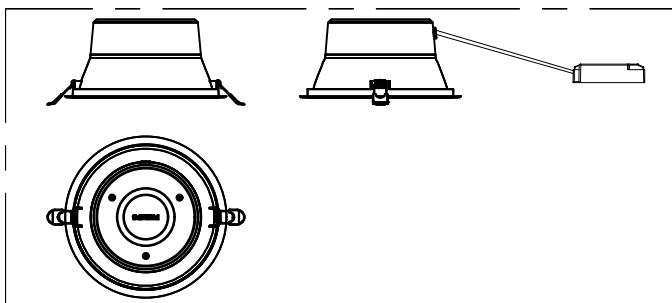

## GreenSpace G6

