



GreenSpace G6

DN393B LED26/830 PSU D200 WH GCG2HE

GreenSpace G6, 19.2 W, 2400 lm, 3000 K, White reflector and opal cover, Matte, IP20 | Finger-protected

Philips GreenSpace G6 builds on the GreenSpace family's reputation for superb performance, extremely low energy use, and high visual comfort. This next generation of reliable LED downlights comes in a highly-compact design with a deep, recessed architecture and increased reflector depth to highlight the smallest of details. GreenSpace G6 is also a shining example of versatility. This energy-saving LED downlight is available in a comprehensive range of configurations from 600 to 3,550 lumen, with the option to choose fixed, dimmable, or Interact Ready variants. This makes GreenSpace G6 the perfect 'mix and match' solution for potentially broad and extended applications that require different lighting ambiances, with one cohesive luminaire look and feel.

Product data

| General Information | | Optic type | |
|------------------------------------|----------------|--------------------------------|--|
| Number of gear units | - | White reflector and opal cover | |
| Gear | - | Optical cover type | |
| Driver included | Yes | Polycarbonate Diffuser | |
| Light source engine type | LED | Unified glare rating CEN | |
| | | 25 | |
| Light Technical | | Operating and Electrical | |
| Luminous Flux | 2,400 lm | Input Voltage | 220 to 240 V |
| Luminous Efficacy (rated) (Nom) | 130 lm/W | Line Frequency | 50 or 60 Hz |
| Correlated Color Temperature (Nom) | 3000 K | Inrush current | 10 A |
| Color rendering index (CRI) | >80 | Inrush time | 0.02 ms |
| Number of light sources | 1 | Power Consumption | 19.2 W |
| Light source color | 830 warm white | Power Factor (Fraction) | 0.9 |
| | | Connection | Flying leads/wires |
| | | Cable | 2×0.75mm ² Cable 0.2 m without plug |

GreenSpace G6

| | |
|--|----------------------------------|
| Number of products on MCB of 16 A type B 170 | |
| Temperature | |
| Ambient temperature range | -20 to +40 °C |
| Controls and Dimming | |
| Dimmable | No |
| Control interface | - |
| Mechanical and Housing | |
| Housing Material | Aluminum die-cast |
| Reflector material | Polycarbonate |
| Optic material | Polycarbonate |
| Optical cover material | Polycarbonate |
| Housing Color | Aluminum |
| Mounting device | Frame for recessed mounting |
| Optical cover finish | Matte |
| Overall height | 107 mm |
| Overall diameter | 216 mm |
| Approval and Application | |
| Ingress protection code | IP20 [Finger-protected] |
| Mech. impact protection code | IK03 [0.3 J] |
| Protection class IEC | Safety class II |
| Glow-wire test | Temperature 650 °C, duration 5 s |
| Flammability mark | - |
| CE mark | CE mark |
| ENEC mark | - |

| | |
|----------------------|--|
| Warranty period | 3 years |
| Photobiological risk | Photobiological risk group 1 @200mm to EN62778 |
| EU RoHS compliant | Yes |

| | |
|--|--------|
| Initial Performance (IEC Compliant) | |
| Luminous flux tolerance | +/-10% |
| Initial chromaticity | 5 |
| Power consumption tolerance | +/-10% |

| | |
|------------------------------------|----------------|
| Application Conditions | |
| Performance ambient temperature Tq | 25 °C |
| Maximum dim level | Not applicable |
| Suitable for random switching | No |

| | |
|---------------------------------|-------------------------------------|
| Product Data | |
| Order product name | DN393B LED26/830 PSU D200 WH GCG2HE |
| Full product name | DN393B LED26/830 PSU D200 WH GCG2HE |
| Order code | 911401528444 |
| Material Nr. (12NC) | 911401528444 |
| Numerator - Quantity Per Pack | 1 |
| Net Weight (Piece) | 0.440 kg |
| Numerator - Packs per outer box | 4 |

Dimensional drawing

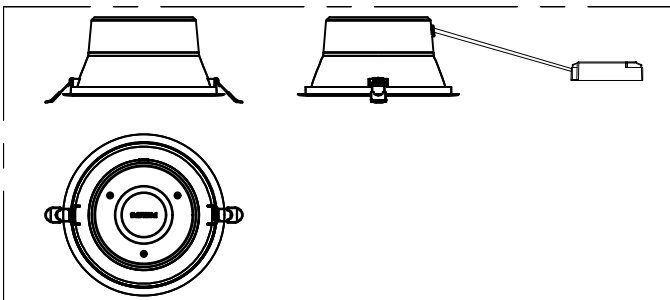

GreenSpace G6

