



GreenSpace G6

DN393B LED26/865 P20PSD D200 WH GMG2HE

GreenSpace G6, 19.9 W, 2600 lm, 6500 K, DALI, White reflector and opal cover, Matte, IP20 | Finger-protected

Philips GreenSpace G6 builds on the GreenSpace family's reputation for superb performance, extremely low energy use, and high visual comfort. This next generation of reliable LED downlights comes in a highly-compact design with a deep, recessed architecture and increased reflector depth to highlight the smallest of details. GreenSpace G6 is also a shining example of versatility. This energy-saving LED downlight is available in a comprehensive range of configurations from 600 to 3,550 lumen, with the option to choose fixed, dimmable, or Interact Ready variants. This makes GreenSpace G6 the perfect 'mix and match' solution for potentially broad and extended applications that require different lighting ambiances, with one cohesive luminaire look and feel.

Product data

General Information		Light source color	
Number of gear units	-	Light source color	865 cool daylight
Gear	-	Optic type	White reflector and opal cover
Driver included	No	Optical cover type	Polycarbonate Diffuser
Light source engine type	LED	Unified glare rating CEN	Not applicable
Light Technical		Operating and Electrical	
Luminous Flux	2,600 lm	Input Voltage	220 to 240 V
Luminous Efficacy (rated) (Nom)	137 lm/W	Line Frequency	50 or 60 Hz
Correlated Color Temperature (Nom)	6500 K	Inrush current	16.5 A
Color rendering index (CRI)	≥80	Inrush time	177 ms
Number of light sources	48	Power Consumption	19.9 W
Beam angle of light source	10 or 40 degree(s)	Power Factor (Fraction)	0.9
		Connection	2 Push-in connector 2-pole

GreenSpace G6

Cable	-
Number of products on MCB of 16 A type B	36
Temperature	
Ambient temperature range	-20 to +40 °C
Controls and Dimming	
Dimmable	DALI
Control interface	DALI
Mechanical and Housing	
Housing Material	Aluminum die-cast
Reflector material	Polycarbonate
Optic material	Polycarbonate
Optical cover material	Polycarbonate
Housing Color	Aluminum and RAL (to be defined)
Mounting device	Frame for recessed mounting
Optical cover finish	Matte
Overall height	107 mm
Overall diameter	216 mm
Approval and Application	
Ingress protection code	IP20 [Finger-protected]
Mech. impact protection code	IK03 [0.3 J]
Protection class IEC	Safety class II
Glow-wire test	Temperature 650 °C, duration 5 s
Flammability mark	-
CE mark	CE mark

ENEC mark	-
Warranty period	3 years
Photobiological risk	Photobiological risk group 1 @200mm to EN62778
EU RoHS compliant	Yes

Initial Performance (IEC Compliant)	
Luminous flux tolerance	-10% / +10%
Initial chromaticity	5
Power consumption tolerance	+/-10%

Application Conditions	
Performance ambient temperature Tq	25 °C
Maximum dim level	1%
Suitable for random switching	No

Product Data	
Order product name	DN393B LED26/865 P20PSD D200 WH GMG2HE
Full product name	DN393B LED26/865 P20PSD D200 WH GMG2HE
Order code	911401572844
Material Nr. (12NC)	911401572844
Numerator - Quantity Per Pack	1
Net Weight (Piece)	0.590 kg
Numerator - Packs per outer box	1

Dimensional drawing

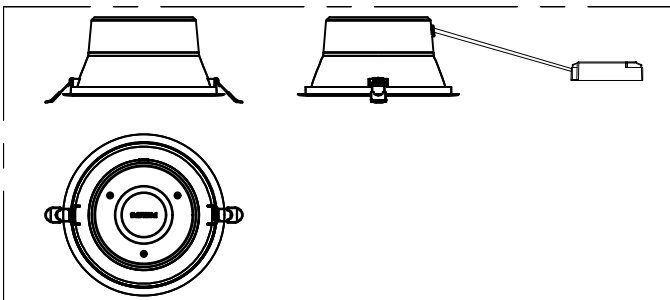

GreenSpace G6

