



GreenSpace G6

DN394B LED40/830 P29PSD D200 WH GMG2HE

GreenSpace G6, 29.3 W, 3700 lm, 3000 K, DALI, White reflector and opal cover, Matte, IP20 | Finger-protected

Philips GreenSpace G6 builds on the GreenSpace family's reputation for superb performance, extremely low energy use, and high visual comfort. This next generation of reliable LED downlights comes in a highly-compact design with a deep, recessed architecture and increased reflector depth to highlight the smallest of details. GreenSpace G6 is also a shining example of versatility. This energy-saving LED downlight is available in a comprehensive range of configurations from 600 to 3,550 lumen, with the option to choose fixed, dimmable, or Interact Ready variants. This makes GreenSpace G6 the perfect 'mix and match' solution for potentially broad and extended applications that require different lighting ambiances, with one cohesive luminaire look and feel.

Product data

General Information	
Number of gear units	-
Gear	-
Driver included	No
Light source engine type	LED
Light Technical	
Luminous Flux	3,700 lm
Luminous Efficacy (rated) (Nom)	127 lm/W
Correlated Color Temperature (Nom)	3000 K
Color rendering index (CRI)	≥80
Number of light sources	78
Beam angle of light source	10 or 40 degree(s)

Light source color	830 warm white
Optic type	White reflector and opal cover
Optical cover type	Polycarbonate Diffuser
Unified glare rating CEN	Not applicable
Operating and Electrical	
Input Voltage	220 to 240 V
Line Frequency	50 or 60 Hz
Inrush current	16.5 A
Inrush time	177 ms
Power Consumption	29.3 W
Power Factor (Fraction)	0.9
Connection	2 Push-in connector 2-pole

GreenSpace G6

Cable	-
Number of products on MCB of 16 A type B	36
Temperature	
Ambient temperature range	-20 to +40 °C
Controls and Dimming	
Dimmable	DALI
Control interface	DALI
Mechanical and Housing	
Housing Material	Aluminum die-cast
Reflector material	Polycarbonate
Optic material	Polycarbonate
Optical cover material	Polycarbonate
Housing Color	Aluminum and RAL (to be defined)
Mounting device	Frame for recessed mounting
Optical cover finish	Matte
Overall height	107 mm
Overall diameter	216 mm
Approval and Application	
Ingress protection code	IP20 [Finger-protected]
Mech. impact protection code	IK03 [0.3 J]
Protection class IEC	Safety class II
Glow-wire test	Temperature 650 °C, duration 5 s
Flammability mark	-
CE mark	CE mark

ENEC mark	-
Warranty period	3 years
Photobiological risk	Photobiological risk group 1 @200mm to EN62778
EU RoHS compliant	Yes

Initial Performance (IEC Compliant)	
Luminous flux tolerance	-10% / +10%
Initial chromaticity	5
Power consumption tolerance	+/-10%

Application Conditions	
Performance ambient temperature Tq	25 °C
Maximum dim level	1%
Suitable for random switching	No

Product Data	
Order product name	DN394B LED40/830 P29PSD D200 WH GMG2HE
Full product name	DN394B LED40/830 P29PSD D200 WH GMG2HE
Order code	911401571844
Material Nr. (12NC)	911401571844
Numerator - Quantity Per Pack	1
Net Weight (Piece)	0.590 kg
Numerator - Packs per outer box	1

Dimensional drawing

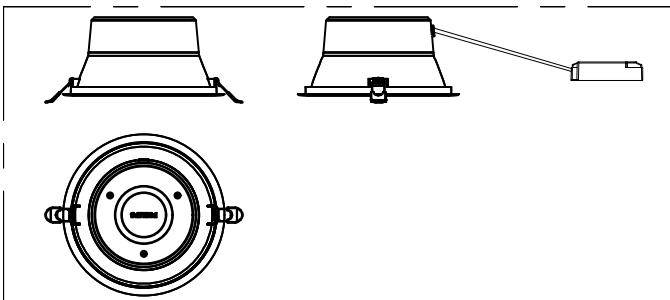

GreenSpace G6

